



inoxair.gr

COMPREHENSIVE SOLUTIONS IN PROFESSIONAL CATERING EQUIPMENT,
STAINLESS STEEL FABRICATIONS, VENTILATION & AIR CONDITIONING
SYSTEMS

Stainless Steel Fabrications



INOXAIR

Product Catalog
2026





Table of Contents

Our Mission.....	3
Professional Charcoal Grills.....	4
Electric Chicken & Lamb Rotisseries.....	17
Professional Exhaust Hoods.....	20
Tables - Shelving Units - Workbenches.....	24
Sinks - Hand Wash Basins.....	28
Carts & Transport Trolleys.....	31
Cupboards & Cabinets.....	34



Our mission

INOX AIR Single-Member LLC is a Greek company operating in the field of catering equipment, offering comprehensive solutions in stainless steel constructions, ventilation systems, and other specialized constructions for professional spaces. The company is based in Tavros, Attica, and serves catering businesses, hotel units, and food industries, providing high-quality products and specialized services in design and maintenance of its manufactured products.

Our mission is to offer our clients not only superior products but also exceptional service, ensuring that every solution we provide meets the highest standards. With care and dedication, we strive to create products that enhance our customers' operations and contribute to their success.

Certifications



INOXAIR

Professional Charcoal Grills





Dimensions (cm)								
Description	A	B	Γ	Δ	E	Z	H	Θ
3 Spit Roast	160	65	150	75	10	65	25	44
6 Spit Roast	160	85	150	75	10	65	25	44
9 Spit Roast	160	120	150	75	10	65	25	44

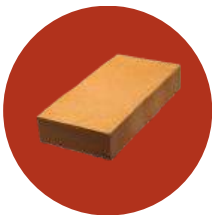
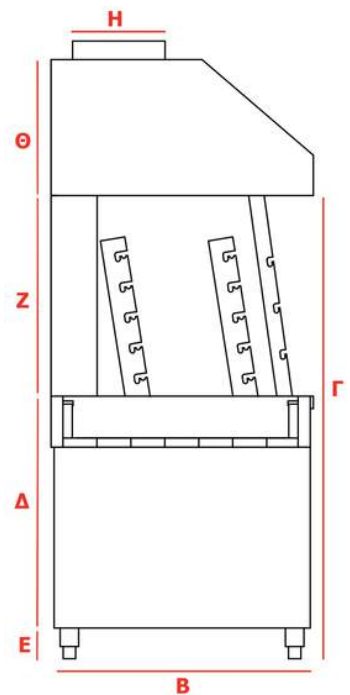

Firebrick installation option

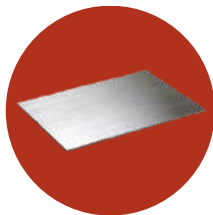

Inox AISI 304 & 430

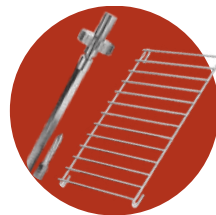

Stainless steel grills & spits

Specifications

- Made of satin stainless steel AISI 430 or 304.
- Nickel-plated grills with rotating rods, dimensions 43x30 cm (3 pieces).
- Option to install two types of electric motors (geared motors): with 12V transformer or 220V geared motor.
- Option to install a 3-speed controller with a 12V geared motor.
- CE Certification.
- AISI 304 Stainless Steel spits and grills.
- Spit length (net blade-to-blade): 135 cm.
- All grills include a firebrick base (11x22x3cm):
- 3 spit model: 43 pieces
- 6 spit model: 56 pieces
- 9 spit model: 76 pieces
- Custom constructions available upon request.



Dimensions (cm)					
Description	A	B	Γ	Δ	E
3 Spit Roast	160	65	150	75	10
6 Spit Roast	160	85	150	75	10
9 Spit Roast	160	120	150	75	10

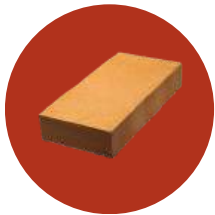
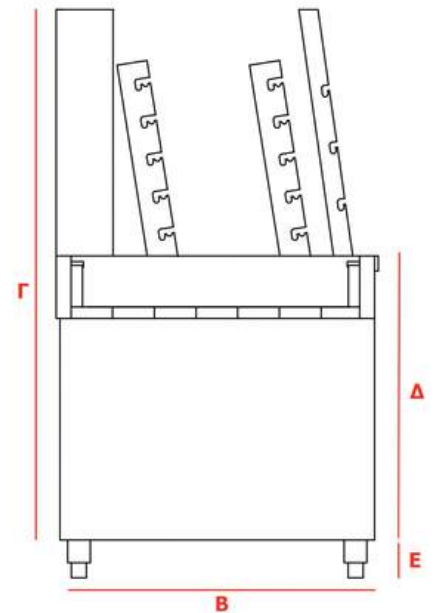

Firebrick installation option

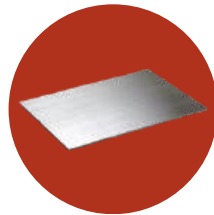

Inox AISI 304 & 430

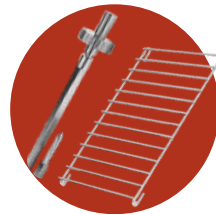

Stainless steel grills & spits

Specifications

- Made of satin stainless steel AISI 430 or 304.
- Nickel-plated grills with rotating rods, dimensions 43x30 cm (3 pieces).
- Option to install two types of electric gear motors: with 12V transformer or SIREM 220V gear motor.
- Option to install a 3-speed controller with a 12V gear motor.
- CE Certification.
- The AISI 304 type features stainless steel (inox) spits and grills.
- Net spit length (blade-to-blade): 135 cm.
- All grills include a base for firebricks (11x22x3cm):
- 3-spit model: 43 pieces
- 6-spit model: 56 pieces
- 9-spit model: 76 pieces
- Custom constructions available upon request.



Dimensions (cm)							
Description	A	B	Γ	Δ	E	Z	H
3 Spit Roast	160	55	143	23	11	65	20
6 Spit Roast	160	80	143	23	11	65	25
9 Spit Roast	160	120	143	23	11	65	25



Firebrick
installation
option

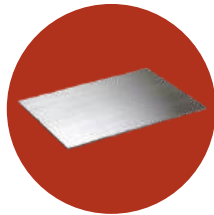

Inox AISI 304
& 430

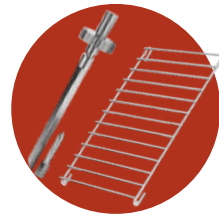

Stainless steel grills
& spits

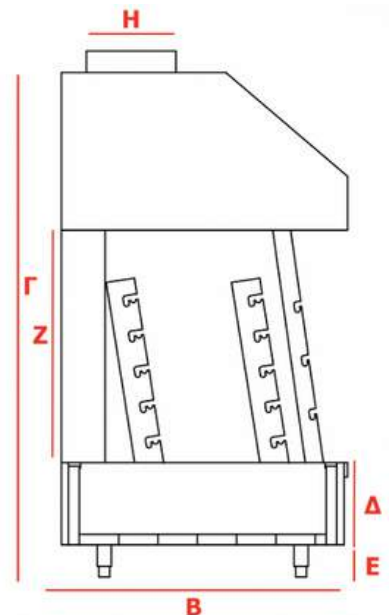

Specifications

- Construction: Made of satin stainless steel AISI 430 or 304.
- Grills: Nickel-plated grills with rotating rods, dimensions 43x30 cm (3 pieces).
- Motor Options: Option to install two types of electric gear motors: with 12V transformer or SIREM 220V gear motor.
- Speed Control: Option to install a 3-speed controller with a 12V gear motor.
- Certification: CE Certification.
- AISI 304 Version: Features stainless steel (inox) spits and grills.
- Spit Dimensions: Net spit length (blade-to-blade): 135 cm.
- Firebrick Base: All grills include a base for firebricks (11x22x3 cm):
- 3-spit model: 43-46 pieces.
- 6-spit model: 56-59 pieces.
- 9-spit model: 76 pieces.
- Customization: Custom constructions available upon request.



Dimensions (cm)						
Description	A	B	Γ	Δ	E	Z
3 Spit Roast	160	55	90	23	11	31
6 Spit Roast	160	80	90	23	11	31
9 Spit Roast	160	120	90	23	11	31

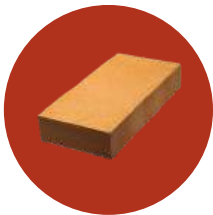
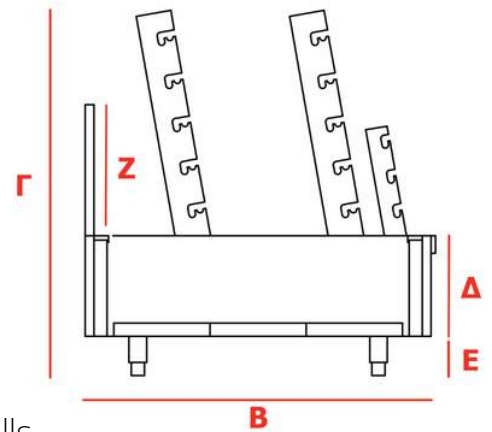

Firebrick installation option

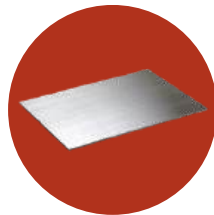

Inox AISI 304 & 430

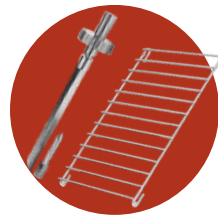

Stainless steel grills & spits

Specifications

- Construction: Made of satin stainless steel AISI 430 or 304.
- Grills: Nickel-plated grills with rotating rods, dimensions 43x30 cm (3 pieces).
- Motor Options: Option to install two types of electric gear motors: with 12V transformer or SIREM 220V gear motor.
- Speed Control: Option to install a 3-speed controller with a 12V gear motor.
- Certification: CE Certification.
- AISI 304 Version: Features stainless steel (inox) spits and grills.
- Spit Dimensions: Net spit length (blade-to-blade): 135 cm.
- Firebrick Base: All grills include a base for firebricks (11x22x3 cm):
- 3-spit model: 43-46 pieces.
- 6-spit model: 56-59 pieces.
- 9-spit model: 76 pieces.
- Customization: Special constructions available upon request.



Dimensions (cm)			
Description	A	B	Г
3 Spit Roast	180	65	200
6 Spit Roast	180	85	200
9 Spit Roast	180	120	200



Fire-resistant glass panels

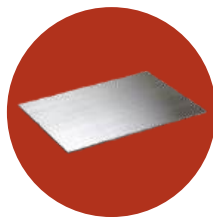

Inox AISI 430

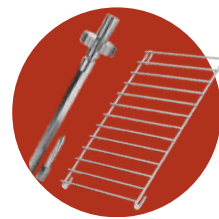

Stainless steel grills & spits

Specifications

- Made of satin stainless steel AISI 430.
- Nickel-plated grills with rotating rods, dimensions 43x30 cm (3 pieces).
- Option to install two types of motors: with 12V transformer or SIREM 220V gear motor.
- CE Certification.
- Fire-resistant glass panels.
- Net spit length (blade-to-blade): 135 cm.
- All grills include a base for firebricks (11x22x3cm):
- 3-spit model: 46 pieces.
- 6-spit model: 59 pieces.
- 9-spit model: 76 pieces.
- Custom constructions available upon request.



Dimensions (cm)				
Description	A	B	Γ	Δ
4 Spit Roast	180	65	210	25
8 Spit Roast	180	100	210	30
12 Spit Roast	180	140	210	30

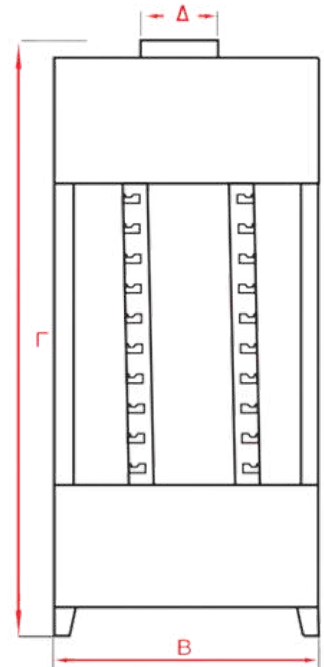

Fire-resistant glass panels

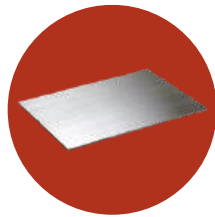

Inox AISI 304

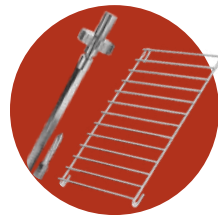

Stainless steel grills & spits

Specifications

- Made of satin stainless steel AISI 304.
- Support base for metal filters in the hood.
- SIREM 220V gear motor per axis.
- Portable with heavy-duty wheels.
- Fire-resistant glass panels.
- Internal lighting in the roasting cabin.
- CE Certification.
- Net spit length (blade-to-blade): 135 cm.
- Custom constructions available upon request.



Dimensions (cm)

Description	A	B	Γ
4 Spit Roast	180	195	100

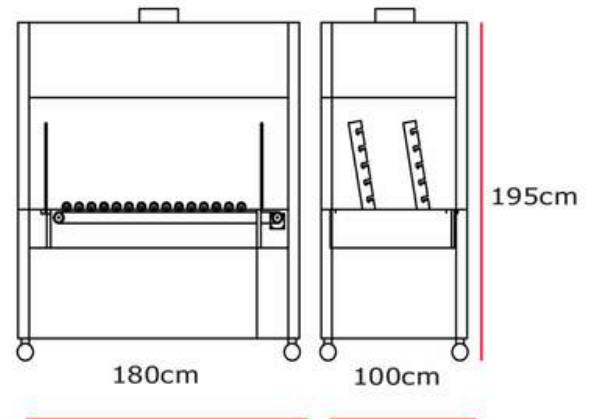

Fire-resistant glass panels

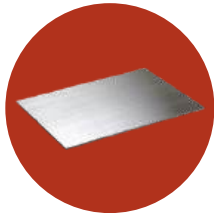

Inox AISI 430

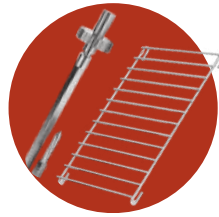

Stainless steel grills & spits

Specifications

- Made of satin stainless steel AISI 430.
- Equipped with 8 rotating spits (Φ8) for "kontosouvli" and 6 square spits for lamb and "kokoretsi".
- Portable with heavy-duty wheels.
- Features a SIREM 220V gear motor, suitable for roasting lamb.
- Fire-resistant glass panels.
- CE Certification.
- Custom constructions available upon request.

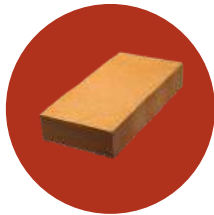
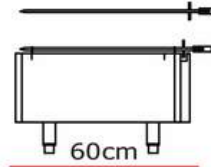
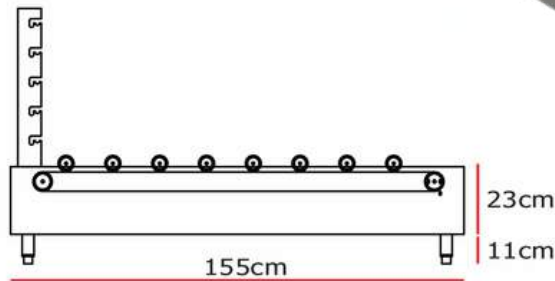

Firebrick
installation
option

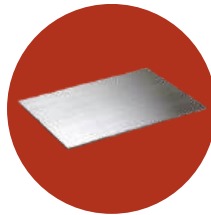

Inox AISI
304

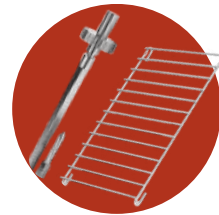

Stainless steel grills
& spits

Specifications

- "Kontosouvli" charcoal grill.
- Made of stainless steel AISI 430.
- Equipped with 8 rotating spits ($\Phi 8$) for "kontosouvli".
- Includes support blades for easy storage.
- Large cooking surface with 3 grill pieces.
- Custom constructions available upon request.



Dimensions (cm)
Single Level
50 x 53 x 34
100 x 53 x 34
150 x 53 x 34
200 x 53 x 34

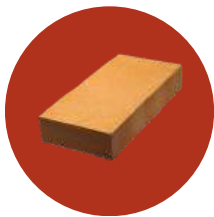
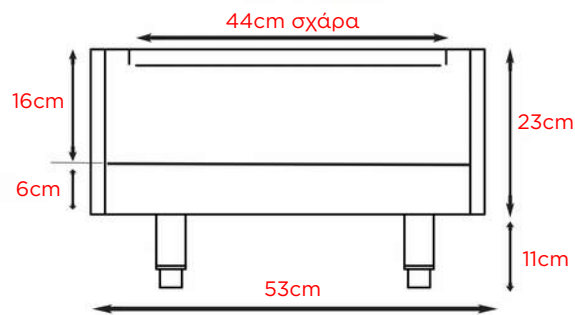

Firebrick
installation
option

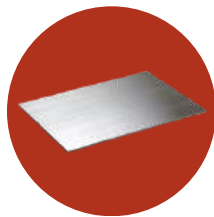

Inox AISI 304
& 430

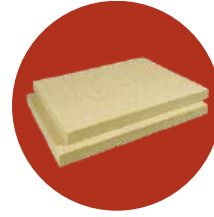

Additional rock
wool insulation

Specifications

- Made of satin stainless steel AISI 430 or 304.
- Nickel-plated grills with rotating rods.
- Features an independent internal D.K.P. tray that is removable for easy cleaning.
- These charcoal grills include a base for firebricks and a specially designed hollow space underneath to prevent countertops from overheating.
- Option for 2-level construction.
- Option for construction with a backslash and a drawer.
- Custom constructions available upon request.

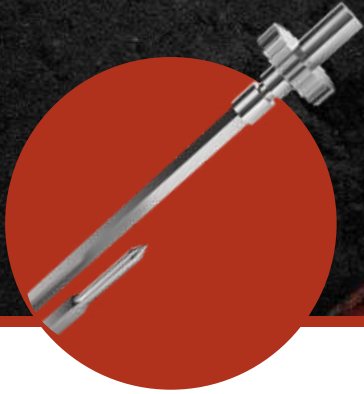

Spits

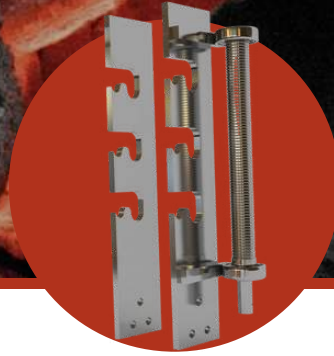

Blades & Worm Gears



Motors & Gear Motors



Cooking Grills



Lamb Back Forks /
Double Forks



Worm Gear Brackets

Description	Price
Spits & Blade 135cm	
Stainless Steel Spits	
5-Position Blades (Chrome-plated 68cm)	
Chrome-plated Supports	
Hooks	
Worm Gears 67cm	
Chrome-plated Spit Gear Handles	
220V SIREM Gear Motor	
12V Gear Motor	

Description	Price
AUTOM 220V Motor	
12V Transformer	
Transmission Gear	
Drive Chain / m	
3-piece Grill Set with Frame (130x30cm)	
Worm Gear Bracket	
Lamb Back Fork	
Charcoal Grill Rack (45x41cm)	

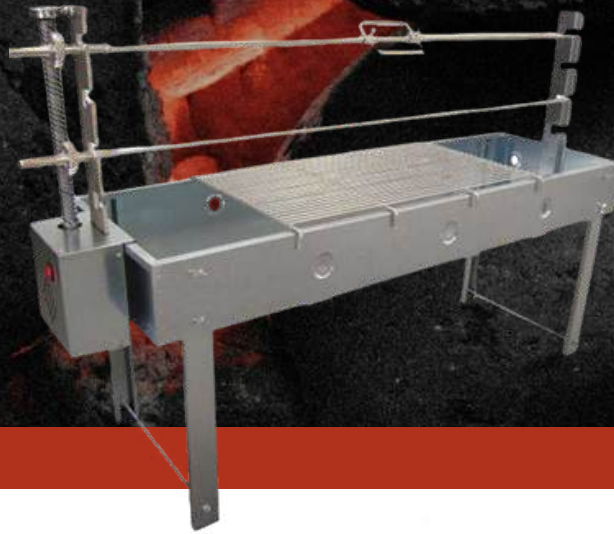

Description	A(cm)	B(cm)	Γ(cm)	Price
Single (2 Spits)	150	45	60	
Double (4 Spits)	150	76	60	

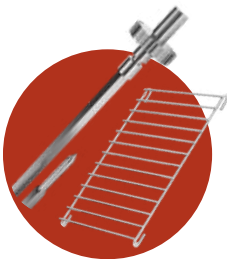
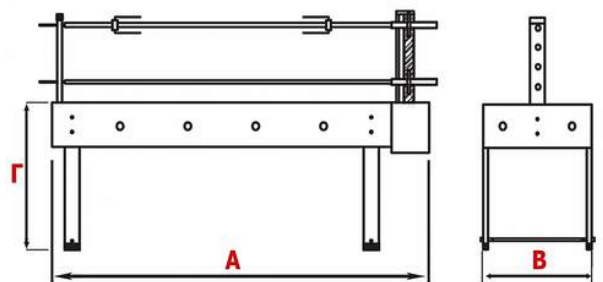

Spits & Grills

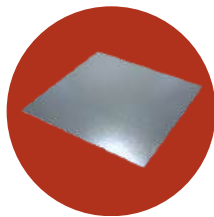

Galvanized Sheet Metal



Wheels for Easy Transport

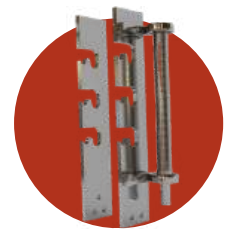

Spit Mechanism

Specifications

- Grill for 2 or 4 spits, made of galvanized sheet metal.
- Detachable support legs with wheels for easy transport.
- Detachable gear mechanism (worm gear).
- Easy to transport and assemble.
- Custom constructions available upon request.



Description	Price
Charcoal Grill 88x45x80cm	

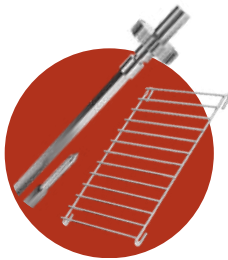
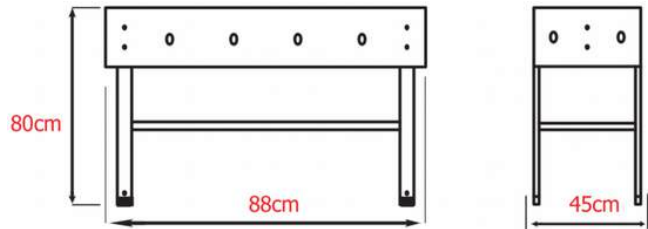

Spits & Grills

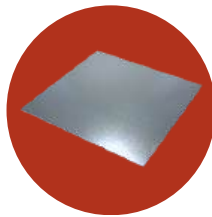

Galvanized Sheet Metal



Wheels for Easy Transport

Specifications

- Grill for 2 or 4 spits, made of galvanized sheet metal.
- Detachable support legs with wheels for easy transport.
- Height-adjustable shelf.
- Easy to transport and assemble.
- Custom constructions available upon request.

INOXAIR

Electric Chicken & Lamb Rotisseries





Description	A(cm)	B(cm)	Γ(cm)
Electric Grill (5 Spits) Inox 304	185	70	180



Fire-resistant
glass panels

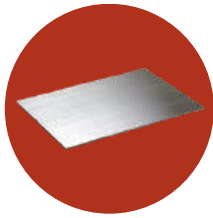

Inox AISI
304

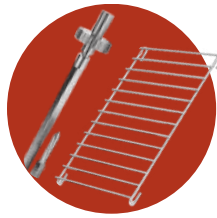

Spits & Grills

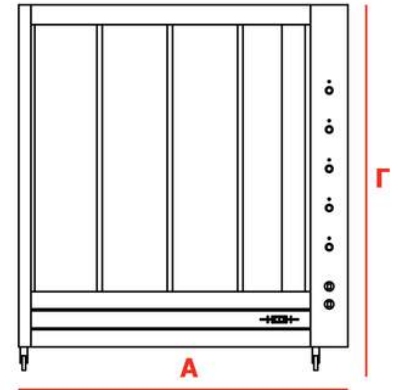
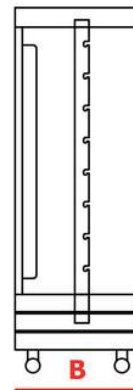

Specifications

- Closed-type grill operating on 11.5kW power.
- Equipped with 4 parallel fire-resistant safety glass panels. This provides the user with unique ease for inserting and removing a fully loaded spit within the grill.
- Exceptional roasting quality at high speed.
- Does not "boil" the meat; it roasts it to perfection, simulating charcoal results.
- Features a water drainage system at the bottom for quick and easy cleaning.
- Equipped with 4 heavy-duty rotating wheels, 2 of which feature brakes.
- SIREM 220V gear motor.



Description	A(cm)	B(cm)	Γ(cm)
Electric Grill (3 Spits) 4kW	130	45	90



Fire-resistant
glass panels

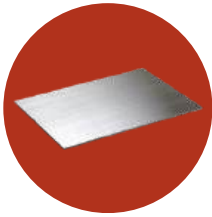

Inox AISI
304

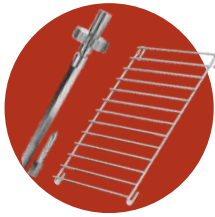

Spits & Grills

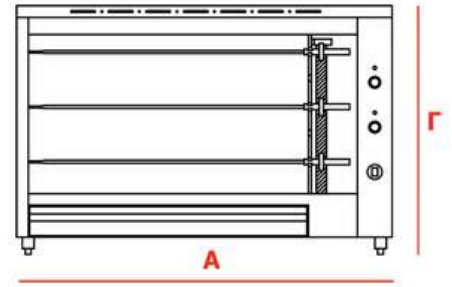
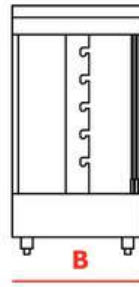

Specifications

- Made of stainless steel with a fire-resistant glass front display.
- The chamber features internal lighting for easy monitoring of the roasting process.
- In addition to chicken, it is recommended for all types of spit-roasted meats (lamb, "kokoretsi", "kefalaki", etc.), guaranteeing fast, delicious, clean, and economical roasting.

INOXAIR

Professional Exhaust Hoods

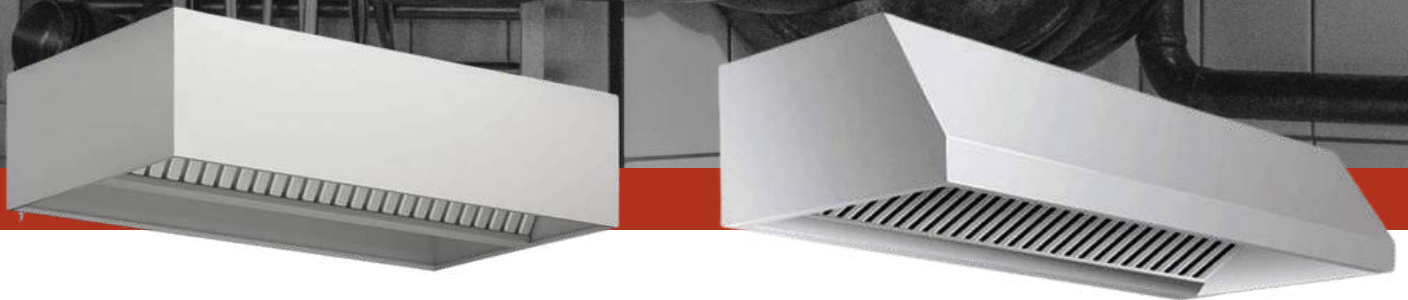

Internal Lighting

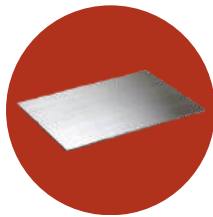

Inox AISI 304



Hood Filters

Dimensions (cm)	
50x90x58	247x90x58
100x90x58	297x90x58
150x90x58	350x90x58
197x90x58	397x90x58

*Valid for all the above models

Specifications

Simple & Box Type

- Filter housing (filters not included).
- Oil drainage pipe.
- Entirely stainless steel construction.
- Optional lighting (bulkhead light fitting).

Dual Energy / Induction

- Extraction of smoke and combustion gases.
- Air replacement of approximately 70% of the exhausted air.
- Fresh air intake from the external environment.
- Improved energy efficiency of the space.



Snack Hoods

Dimensions (cm)

50x70x60
100x70x60
150x70x60
197x70x60
247x70x60
297x70x60
350x70x60
397x70x60

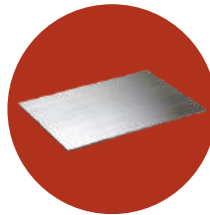

Inox AISI 304



Internal Lighting



Hood Filters

Central Hoods

Dimensions (cm)

150x180x58
197x180x58
247x180x58
297x180x58
350x180x58
397x180x58

Specifications

Snack Hood

- Filter housing (filters not included).
- Oil drainage pipe.
- Entirely stainless steel construction.
- Optional lighting (bulkhead light fitting).

Central Hood

- Double-row filter housing (filters not included).
- Oil drainage pipe.
- Entirely stainless steel construction.
- Optional lighting (bulkhead light fitting).

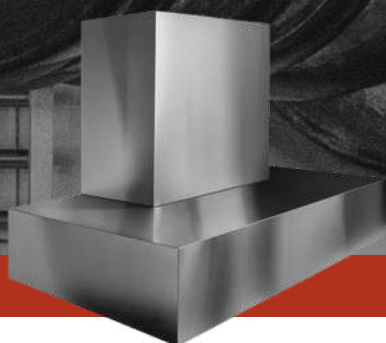

Professional Kitchen Exhaust Hood

- High-efficiency motor: 1350m³/h.
- Lighting: Equipped with spot-type lamps.
- Filters: Metallic, washable grid-type filters.
- Construction Material: Inox AISI 304.
- Control: Operated with a rheostat (dimmer).

Type	Flow Rate m ³ /h	Dimensions (cm)	Price
F1000	1350	100x61x21	
F1200	1350	120x61x21	
F1500	1350	150x61x21	

Hood Filters



Description	Dimensions (cm)	Price
Grid Filter 304	50x50x3	Upon Request
Grid Filter 430	50x50x3	Upon Request

Description	Dimensions (cm)	Price
Wire Mesh Filter	50x50x3	Upon Request
Wire Mesh Filter	50x50x3	Upon Request

INOXAIR

Tables - Shelving Units -
Workbenches



Stainless Steel Worktables

- INOX worktables.
- Made of AISI 304 stainless steel sheet with a thickness of 0.8mm.
- Available in lengths from 50cm to 350cm.
- Custom dimensions available upon request to meet the specific requirements of your space.

Dimensions (cm)	Price (Standard)	Price (with Undershelf)
90x70x86	Upon Request	Upon Request
120x70x86	Upon Request	Upon Request
140x70x86	Upon Request	Upon Request
160x70x86	Upon Request	Upon Request
188x70x86	Upon Request	Upon Request
220x70x86	Upon Request	Upon Request
238x70x86	Upon Request	Upon Request

With intermediate shelf



With wheels



Detachable



Fixed



Tabletop Shelving Units



Dimensions (cm)	Price (Detachable)	Price (Fixed)
88x60x180	Upon Request	Upon Request
120x60x180	Upon Request	Upon Request
150x60x180	Upon Request	Upon Request
190x60x180	Upon Request	Upon Request

Tabletop Shelving Units

Dimensions (cm)	Price (Single)	Price (Double)
100x38x35 (70)	Upon Request	Upon Request
120x38x35 (70)	Upon Request	Upon Request
140x38x35 (70)	Upon Request	Upon Request
160x38x35 (70)	Upon Request	Upon Request
190x38x35 (70)	Upon Request	Upon Request



Dimensions (cm)	Slotted / Tubular Shelf
100x35	
150x35	
200x35	
250x35	
300x35	

Dimensions (cm)	Solid Wall Shelf
100x35	
150x35	
200x35	
250x35	
300x35	



Sorting Table

- Made of AISI 304 stainless steel sheet with a thickness of 0.8mm.
- Height-adjustable feet.
- Features a scrapping hole for waste.
- Robust construction.
- Heavy-duty shelf.

Dimensions (cm)	Price (€)
88×70×86	
128×70×86	
140×70×86	
160×70×86	
188×70×86	

Waste Bins



With Lid

Dimensions (cm)	Price (€)
40x68	

Without Lid

Dimensions (cm)	Price (€)
40x68	

Deboning Benches



Dimensions (cm)	Price (€)
40x40x85	
50x50x85	
60x60x85	
70x70x85	



INOXAIR

Sinks - Hand Wash Basins





Dimensions (cm)	Price (€) Open	Price (€) Closed	Number of Bowls
70x70x86			1 Bowl
120x70x86			
140x70x86			
180x70x86			2 Bowls
240x70x86			
180x70x86			3 Bowls
240x70x86			

Dimensions (cm)	Price (€) Open	Price (€) Closed	Number of Bowls
70x60x86			1 Bowl
120x60x86			
140x60x86			
180x60x86			2 Bowls
240x60x86			
180x60x86			3 Bowls
240x60x86			

Open Sink Units

- Open sink units feature a table-style base.
- They provide an economical solution for washing areas that are not in public view.

Closed Sink Units

- Closed sink units feature a cupboard base with sliding doors.
- They function as storage space for detergents while concealing hydraulic siphons from customers' view in open-plan professional kitchens.





Simple Hand Wash Basin

Dimensions (cm)	Code	Price (€)
40x33x23	LV-LP	



Knee-Operated

Dimensions (cm)	Code	Price (€)
40x29x22	LV-PECO	



Foot-Pedal Operated

Dimensions (cm)	Code	Price (€)
40x40x85	LV-P	

Grease Traps

- Constructed from AISI 304 stainless steel.
- Designed to separate grease from other liquids.
- Grease accumulates in the central tank, from where it is collected.



Dimensions mm	Total Capacity (kg)	Grease Capacity (kg)	Price (€)
450x330x270	40	7	
570x450x380	95	15	
680x500x450	159	23	

INOXAIR

Carts & Transport
Trolleys



1 or 2 Tier Cart

- Frame made of AISI 304 stainless steel hollow section.
- Tiers constructed from AISI 304 stainless steel sheet.
- Swivel wheels (two equipped with brakes).
- Custom dimensions available upon request.

Dimensions mm	Price (€)
80x60x90	
100x60x90	

Dish Transport Trolley

- Stainless steel kitchen trolley.
- 3 shelves with a thickness of 0.7 mm.
- Frame thickness: 0.9 mm.
- Φ 10 cm wheels.
- Maximum load per shelf: 50 kg.
- Dimensions: 86 x 54 x 94 cm, Weight: 12.5 kg.

Dimensions mm	Price (€)
86x54x94	



15-Tier Trolley for 400 x 600 mm Trays

- 15-tier service trolley for bakery and pastry trays, dimensions 400 x 600 mm.
- Dimensions: 460 x 630 x 1750 mm.
- Includes 4 swivel wheels (two equipped with brakes).
- 80 mm distance between runners.
- Constructed from AISI 304 stainless steel.

Dimensions mm	Tiers	Price (€)
460x630x175	15	

15-Tier Trolley for GN 1/1 Trays

- 15-tier service trolley for GN 1/1 or 30 GN 1/2 trays.
- Dimensions: 380 x 550 x 1750 mm.
- Includes 4 swivel wheels (two equipped with brakes).
- 80 mm distance between runners.
- Constructed from AISI 304 stainless steel.

Dimensions mm	Tiers	Price (€)
380x550x1750	15	

15-Tier Trolley for GN 2/1 Trays

- 15-tier service trolley for GN 2/1 or 30 GN 1/1 trays.
- Dimensions: 580 x 680 x 1750 mm.
- Includes 4 swivel wheels (two equipped with brakes).
- 80 mm distance between runners.
- Constructed from AISI 304 stainless steel.

Dimensions mm	Tiers	Price (€)
580x680x1750	15	

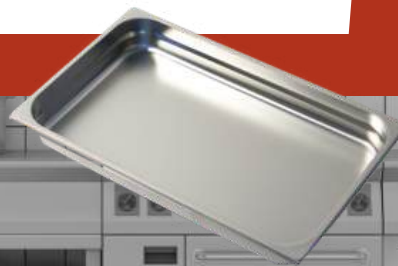

INOXAIR

Cupboards & Cabinets





Storage Cupboards & Heated Cabinets

- Constructed from satin-finish AISI 304 stainless steel.
- Flawless finish.
- Height-adjustable feet.
- Equipped with one intermediate shelf.
- Note: For cupboards with double-sided sliding doors (front-back), an additional 50% surcharge applies.
- Note: For pass-through cupboards, a price reduction of 25% applies.

Sliding Hinged Doors

Dimensions cm	Price (€)	Price (€)
90×70×86		
120×70×86		
140×70×86		
160×70×86		
188×70×86		
220×70×86		
238×70×86		



Heated Cupboards with Sliding Doors

- Constructed from satin-finish AISI 304 stainless steel.
- Height-adjustable feet.
- Indicative operation light.
- Resistance thermostat.
- Heated storage area with shelf.
- Temperature range: 0°C to +90°C.
- Analog thermostat.
- Power: 2000W.
- Voltage / Frequency: 220-240V / 50Hz.
- Equipped with sliding doors.

Dimensions cm	Price (€)
90×70×86	
120×70×86	
140×70×86	
160×70×86	
188×70×86	
220×70×86	
238×70×86	



Storage Cupboards

- Constructed from satin-finish AISI 304 stainless steel.
- Flawless finish.
- Height-adjustable feet.
- Equipped with three adjustable shelves.
- Option: Available in galvanized steel sheet with electrostatic powder coating in various colors.

Sliding Doors

Dimensions cm	Price (€)
120x70-60x200	
140x70-60x200	
160x70-60x200	
190x70-60x200	

Hinged Doors

Dimensions cm	Price (€)
120x70-60x200	
140x70-60x200	
160x70-60x200	

Drawer Unit with Flour/Grain Bin



Dimensions cm	Price (€) with 3 Drawers
50x70x86	

Cabinet with Bin



Dimensions cm

50x70x86

Price (€) with Bottom Shelf

Coffee Machine Drawer Unit



Dimensions cm

50x50x23

85x50x23

Number of Drawers

Price (€)

Drawer Unit



Dimensions cm

100x70x86

Price (€) with 3 Drawers



Wall-Mounted Cup Units

- Constructed from AISI 304 stainless steel.
- Excellent build quality.
- Features aluminum tracks and ball-bearing rollers for smooth sliding.

Dimensions (cm) with 1 Adjustable Shelf & Sliding Doors

Dimensions (cm)	Price (€)
100x40x70	
120x40x70	
140x40x70	
160x40x70	
190x40x70	
220x40x70	
240x40x70	

Dimensions (cm) with 2 Fixed Shelves & Glass Sliding Doors

Dimensions (cm)	Price (€)
100x30x70	
120x30x70	
140x30x70	
160x30x70	
190x30x70	
220x30x70	
240x30x70	



Multi-Functional Cupboard

- Entirely constructed from stainless steel.
- Height-adjustable feet.
- Features stainless steel drawers.
- Includes an open stainless steel bin.
- Upper section features a cupboard unit with glass sliding doors.

Dimensions (cm)	Price (€)
100x70-60x195	



Bain Marie with Showcase

- Constructed from stainless steel.
- Height-adjustable stainless steel feet.
- Indicative operation light.
- Resistance thermostat.
- Water outlet valve (drain).
- Water-submersible resistance heating element.

Dimensions (cm)	GN 1/1 Pans	Power (kW)	Price (€)
110x70x130	3	2.45	
140x70x130	4	4.45	
180x70x130	5	4.45	



Dimensions (cm)	GN 1/1 Pans	Power (kW)	Price (€)
80x70x70	2	2.3	
120x70x70	3	2.45	
140x70x70	4	2.60	



Open Fish Displays

- Constructed from stainless steel.
- Height-adjustable rear feet.
- Inclined top surface for optimal display and drainage.
- Robust construction.
- Integrated drainage system.

Dimensions (cm)	Price (€)
120x115x90-105	
160x115x90-105	
200x115x90-105	



Closed Fish Displays

- Constructed from stainless steel.
- Height-adjustable feet and inclined top surface.
- Robust construction with drainage.
- The lower section features a cupboard with sliding doors, providing additional storage space.

Dimensions (cm)	Price (€)
120x115x90-105	
160x115x90-105	
200x115x90-105	



*COMPREHENSIVE SOLUTIONS IN
PROFESSIONAL CATERING EQUIPMENT,
STAINLESS STEEL FABRICATIONS,
VENTILATION & AIR CONDITIONING SYSTEMS*